

 megius

mille  
emozionanti  
gocce in u  
no  
spazio

[www.megius.com](http://www.megius.com)

SELECTION 43

mille  
emozionanti  
gocce  
in  
uno  
spazio

SELECTION 43

PIATTI DOCCIA  
SHOWER TRAYS  
PLATOS DE DUCHA  
PRATOS CHUVEIRO  
PLATEAUX  
DUSCHTELLER  
+  doiserie

 megius

 megius



Facilmente lavorabile sul posto  
Easy to work on site  
Fácilmente laborable en el lugar  
Facilmente trabalhável no local  
Facile à travailler sur place  
Einfach arbeiten vor Ort



Personalizzazione estrema  
Extreme Customization  
Personalización extrema  
Personalização extrema  
Personnalisation Extreme  
Extreme Anpassbarkeit



Tecnica di incollaggio all'avanguardia  
Advanced bonding technology  
Sistemas de unión de última generación  
Sistemas de junção de última geração  
La technologie de liaison avancée  
Erweiterte Klebtechnik



Facilmente installabile  
Easy to install  
Fácilmente instalable  
Facilmente instalável  
Facile à installer  
Einfach zu installieren



Piatto e pareti rifiniti su tutti i lati a vista  
Plate and walls finished on all sides to view  
Placa y paredes acabadas en todos los lados visibles  
Chuva plana e paredes acabaram em todos os lados para avistar  
Plate et les murs finis sur tous les côtés pour voir  
Platte und für Wände auf allen Seiten zu betrachten



Adattabile a qualsiasi soluzione doccia  
Adaptable to any shower solutions  
Adaptable a cualquier solución ducha  
Adaptável a qualquer solução de chuveiro  
Adaptable à toutes les solutions de douche  
Anpassungsfähig an jede Duschlösungen



Nessuna specializzazione necessaria in lavori di edilizia avanzati  
No expertise required in advanced construction work  
Ninguna especialización necesaria en trabajos de construcción avanzados  
Nenhuma especialização necessária em obras avançadas  
Aucune expertise nécessaire dans les travaux de construction avancée  
Keine Know-how erforderlich in fortgeschrittenen Bauarbeiten



CORIAN®  
POLICORE  
SMART SP1

**Dai un tocco di stile al tuo bagno con un piatto doccia Megius!**

Give a touch of style to your bathroom with a shower tray Megius!

¡Agrega un toque de estilo a tu baño con un plato de ducha Megius!

Adicione um toque de estilo ao seu banheiro com um chuveiro Megius!

Ajoutez une touche de style à votre salle de bain avec un receveur de douche Megius!

Verleihen Sie Ihrem Badezimmer mit einer Megius-Duschtasse einen Hauch von Stil!

**TECHNART** p.4

**PLATFORM** p.14

**DETAIL** p.20

**CORIAN®** p.28

**POLICORE** p.36

**DOISERIE** p.47

# TECHNART

**IT** Nell'ottica di fornire un total look coordinato e di design, Technart è un elemento di sicuro interesse nel panorama dell'arredobagno.

Composto da una miscela di resine minerali, lo strato superficiale non è soltanto verniciato, bensì viene rivestito esternamente da uno smalto tecnico, Gelcoat, ad affetto estetico opaco che ne migliora le proprietà di pulizia e scivolamento dell'acqua; questo rivestimento abbina ottime caratteristiche di resistenza a completa ripristinabilità della superficie, grazie ad un kit con pasta dello stesso colore.

**EN** In order to provide a total coordinated look and design, Technart is an item of great interest in Bathroom furnishings.

Composed of a mixture of minerals, the surface layer is not only painted, but is externally covered by Gelcoat, an opaque technical glaze that improves the cleanliness of the aesthetic affect and water flow properties; This coating combines excellent resistance to surface full recoverability, thanks to a kit with pasta of the same colour.

**ES** En la óptica de proveer una apariencia y diseño total coordinados, Technart es un elemento de gran interés en el panorama de los muebles de baño.

Compuesta por una mezcla de resinas minerales, la capa superficial no solo está pintada, sino que también está cubierta externamente por un esmalte técnico, Gelcoat, con un efecto estético opaco que mejora las propiedades de limpieza y deslizamiento del agua; Este recubrimiento combina características de resistencia óptimas con una restauración total de la superficie, gracias a un kit con la misma pasta de color.

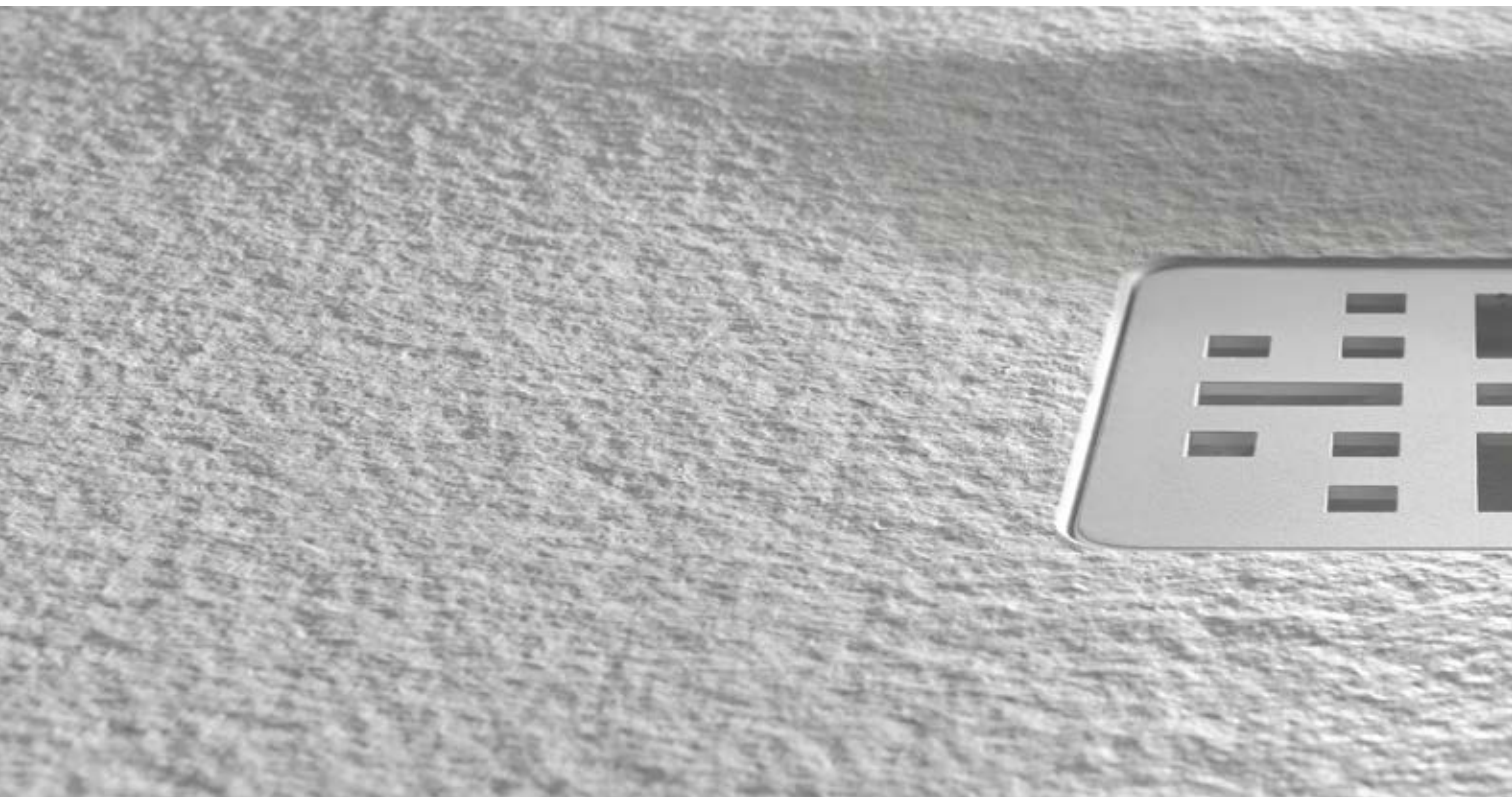

**PT** Com o objetivo de proporcionar um visual e design total coordenados, a Technart é um elemento de grande interesse no panorama da mobília do banheiro.

Composta por uma mistura de resinas minerais, a camada superficial não é apenas pintada, mas é coberta externamente por um esmalte técnico, Gelcoat, com um efeito estético opaco que melhora as propriedades de limpeza e deslizamento da água; Este revestimento combina excelentes características de resistência com a restauração completa da superfície, graças a um kit com massa da mesma cor.

**FR** Afin de donner un look coordonné total et de design, Technart c'est sûr un élément d'intérêt dans les fournitures des salles de bains.

Composé par un mix de résines minérales, la couche superficielle n'est pas uniquement vernie, mais aussi recouverte à l'extérieur par un émail technique, le Gelcoat, à effet mat qui en améliore les propriétés de nettoyage et glissement de l'eau.

Ce revêtement combine des excellentes caractéristiques de résistance à une complète réparation de la surface, grâce à un kit avec composée d'une pâte de la même couleur.

**DE** Um ein einheitliches und perfekt abgestimmtes Design zu gewährleisten, ist Technart ein sehr interessantes Thema in der Badezimmerausstattung. Der Mineralgusskern besteht aus einer Mischung von Mineralen und Harze. Seine Oberflächenschicht wird nicht lackiert, sondern durch einen Gelcoat technisch veredelt und mattiert, so dass nicht nur der ästhetische Effekt, sondern auch die Reinigungsfreundlichkeit und Wasserabweisung verbessert werden. Diese Beschichtung kombiniert ausgezeichnete Oberflächenbeständigkeit mit einer einfachen Reparaturmöglichkeit, dank eines erhältlichen Reparatursets in der passenden Farbe.

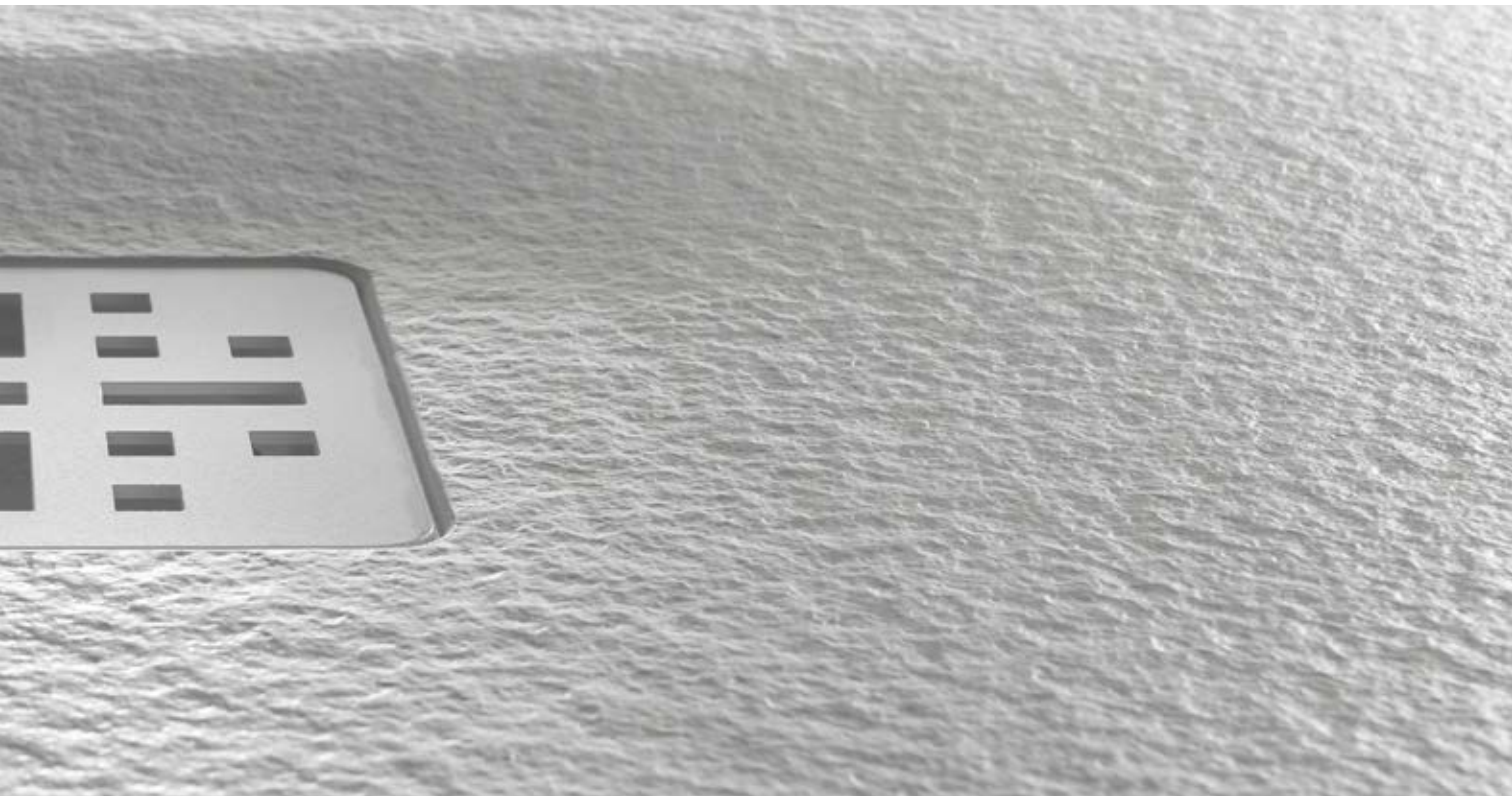





**IT** Resistente agli urti  
**EN** Resistant to shocks  
**ES** Resistente a los golpes

**PT** Resistente a choques  
**FR** Résistant aux chocs  
**DE** Stoßfest



**IT** Resistente agli sbalzi termici  
**EN** Resistant to thermal changes  
**ES** Resistente a los cambios térmicos

**PT** Resistente a alterações térmicas  
**FR** Résistant aux variations thermiques  
**DE** Temperaturwechselbeständig



**IT** Resistente ai raggi UV  
**EN** Resistant to UV rays  
**ES** Resistente a los rayos UV

**PT** Resistente aos raios UV  
**FR** Résistant aux rayons UV  
**DE** UV beständig



**IT** Antiscivolo  
**EN** Non-slip  
**ES** Antideslizante

**PT** Antiderrapante  
**FR** Antidérapant  
**DE** Rutschhemmend



**IT** Resistente alle macchie  
**EN** Resistant to stains  
**ES** Resistente a las manchas

**PT** Resistente a manchas  
**FR** Résistant aux tâches  
**DE** Schmutzabweisend



**IT** Antibatterico  
**EN** Antibacterial  
**ES** Antibacteriano

**PT** Antibacteriano  
**FR** Antibactérien  
**DE** Antibakteriell



**IT** Su misura  
**EN** Customized  
**ES** Personalizado

**PT** Personalizado  
**FR** Sur mesure  
**DE** Personalisiert

**IT** La serie di piatti Technart standard copre tutte le misure comunemente utilizzate, per situazioni più particolari invece, la serie Technart Custom può offrire diverse soluzioni con:

- La versione **Custom 1**, con invaso laterale da 130cm consente il taglio in lunghezza nella parte piana con rigenerazione del bordo in finitura
- La versione **Custom 2** con invaso centrale permette il taglio su tre lati sempre con rigenerazione dei bordi in finitura
- La versione **Custom 3** con misure dedicate in profondità 70/80/90 consente il taglio in lunghezza e la rigenerazione del bordo in finitura.

**EN** The selection of standard Technart covers all measures that are commonly used for special situations, the Technart Custom series can offer different solutions with:

- The **Custom version 1**, with lateral basin from 130 cm, length invaded in the flat part with rebuilding the edge finish.
- The **Custom version 2** with central basin, allows cutting edge always on three sides with regeneration of the border to finish.
- The **Custom version 3** with depth measurements 70/80/90 cm enables cutting to length and regeneration of finishing edge.

**ES** La serie de platos ducha estándar de Technart cubre todos los tamaños utilizados comúnmente, para situaciones más específicas, la serie Technart Custom puede ofrecer diferentes soluciones con:

- La versión **Custom 1**, con cuenca lateral de 130 cm, permite el corte en la parte plana con la regeneración del borde en acabado.
- La versión **Custom 2** con cuenca central, permite el corte sobre tres lados siempre con la regeneración de los bordes acabados.
- La versión **Custom 3** con medidas de cm 70/80/90, permite el corte en largo y la regeneración del bordo en perfeccionamiento.

**PT** A série de placas padrão da Technart abrange todos os tamanhos comumente usados; para situações mais específicas, a série Technart Custom pode oferecer diferentes soluções com:

- A versão **Custom 1**, com extravasamento lateral, permite cortar na parte plana com regeneração da borda no acabamento
- A versão **Custom 2** com tanque central permite o corte de duas partes sempre com regeneração de borda no acabamento
- A versão **Custom 3** com tamanhos dedicados de overgrown 70/80/90.

**FR** La série des receveurs Technart standard englobe toutes les mesures généralement utilisées. Pour les solutions plus spécifiques, la série Technart Custom peut proposer différentes solutions avec:

- La version **Custom 1** bénéficiant d'un réservoir latéral de 130 cm permettant la coupe en longueur dans la partie plane avec régénération du bord en finition.
- La version **Custom 2** bénéficiant d'un réservoir central permettant la coupe en trois parties avec également régénération des bords en finition.
- La version **Custom 3** avec mesures dédiées des recevoirs 70/80/90 qui permet le découpage des recevoirs et la finition parfait du bord.

**DE** Die Auswahl der Standard Technart Duschtassen decken alle gängigen Größe ab. Für Sondermaße kann die Serie Technart Custom verschiedene Lösungen anbieten:

- Die Version **Custom 1** mit seitlichem Teil vom 130 cm ist kürzbar.
- Die Version **Custom 2** mit zentriertem Ablauf auf der Längsseiten dreiseitig kürzbar.
- Die Version **Custom 3** für kleinere Duschköpfe 70/80/90 ermöglicht ein maßstabgerechtes schneiden der duschtasse mit perfekter verarbeiteter kante.



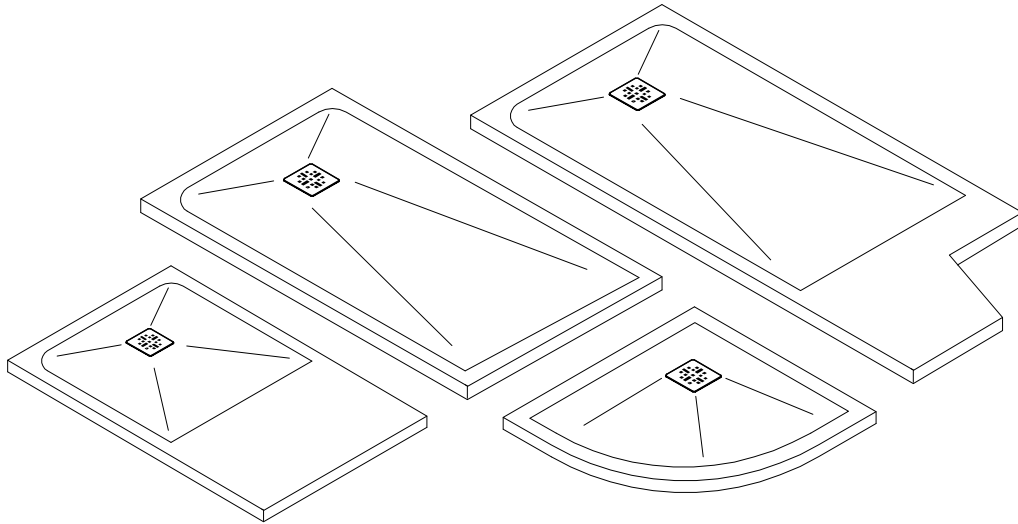

### CUSTOM 1\*

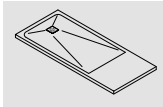

141-160x70

161-180x70

181-200x70

201-220x70

221-230x70

141-160x80

161-180x80

181-200x80

201-220x80

221-230x80

141-160x90

161-180x90

181-200x90

201-220x90

221-230x90

### CUSTOM 2\*

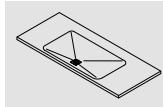

161-180x80

181-200x80

201-220x80

221-230x80

161-180x90

181-200x90

201-220x90

221-230x90

### CUSTOM 3\*

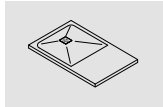

71-141x70

81-141x80

91-141x90

### STANDARD

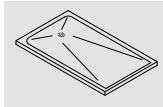

90x70

100x70

120x70

140x70

170x70

80x80

100x80

120x80

140x80

160x80

170x80

180x80

90x90

100x90

140x90

160x90

170x90

180x90

120x90

### ROUND

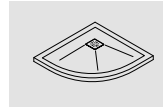

80x80 R\*

90x90 R\*



White - **B**

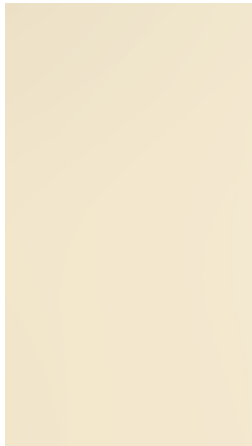

Tortora - **T**



Cappuccino - **D**



Fumo - **F**



Karbon - **K**

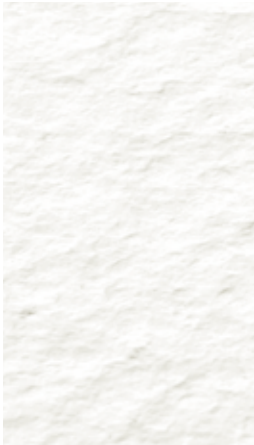

Pietra White - **Z**



Pietra Tortora - **U**



Pietra Cappuccino - **E**



Pietra Fumo - **H**

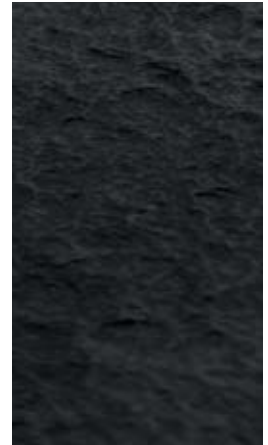

Pietra Karbon - **J**

**IT** Dall'aspetto opaco, le finiture proposte sono liscia oppure Pietra, le colorazioni vanno dal classico bianco al Tortora, al Cappuccino, al grigio Fumo, al nero Karbon, per un ottimale abbinamento con gli altri elementi inseriti nel bagno.

Come standard, anche il copripiletta in acciaio è della stessa tinta del piatto.

Prendersi cura di questi piatti è semplice e veloce. È sufficiente pulire la superficie con acqua saponata o comuni detergenti per rimuovere la maggior parte delle macchie e dello sporco che si possono depositare.

**EN** With a dull appearance, smooth stone finishes or colours are proposals range from classic white to Tortora, Cappuccino, Fumo grey, to Karbon black for an optimal combination with other elements included in the bathroom. As a standard, even steel drain cover is can be chosen in the same solid of the dish.

Take care of these shower tray is quick and easy. Simply clean the surface with soapy water or detergents to remove most of stains and dirt that can be deposited.

**ES** Con una apariencia opaca, los acabados propuestos son lisos o en piedra, los colores van desde el White clásico hasta el Tortora, el Cappuccino, el gris Fumo y el negro Karbon, para una combinación óptima con los otros elementos insertados en el baño.

Como estándar, la tapa de drenaje de color en metal es el mismo color que el plato.

Cuidar de estos platos es rápido y fácil. Es suficiente limpiar la superficie con agua jabonosa o detergentes comunes para eliminar la mayoría de las manchas y la suciedad que se puede depositar.

**PT** Opaco, os acabamentos são lisos ou de pedra, as cores vão do branco clássico à rola, ao cappuccino, ao fumo cinza, ao preto de Karbon, para uma combinação perfeita com os outros elementos inseridos na casa de banho. Como padrão, a tampa de drenagem de aço também pode ser escolhida com a mesma cor do prato. Cuidar desses pratos é rápido e fácil. É suficiente limpar a superfície com água e sabão ou detergentes comuns para remover a maioria das manchas e sujeira que podem ser depositadas.

**FR** Avec aspect mat, les finitions proposées sont lisses ou "Pietra" et leurs couleurs varient dans le blanc classique, au Tortora, au Cappuccino, au gris Fumo, au noir Karbon, pour une coordination idéale avec les autres éléments présent dans la saille de bain. Le couvercle de la bonde est standard en acier inoxydable ou peut être choisi de la même teinte du receveur. Prendre soin de ces receveurs est simple et rapide. Il est suffisant de nettoyer la surface avec de l'eau savonneuse ou des détergents communs pour enlever la plupart de la saleté et les taches qui peuvent se déposer.

**DE** Die matte Ausführungen sind glatt oder strukturiert erhältlich. Die Farben sind klassisches Weiß, Tortora, Cappuccino, Fumo, Karbon schwarz, für eine optimale Kombination mit den anderen Elementen des Badezimmers. Als Standard ist die Ablaufabdeckung aus der gleichen Farbe wie die Duschtasse mitgeliefert (optional auch als Edelstahlfinish erhältlich) Die Pflege diesen Duschtassen ist schnell und einfach. Es reicht aus, die Oberfläche mit Seifenwasser oder herkömmlichen Reinigungsmitteln zu reinigen, um die meisten Ablagerungen und Verschmutzungen zu entfernen.





# PLATFORM

**IT** Le superfici dei piatti Platform sono realizzate con un Mineral Composite, una resina polimerizzata, miscelata omogeneamente con particelle di pigmento e di quarzo; la superficie esterna è protetta da un rivestimento a base di nanotecnologie e questo consente al prodotto di rimanere piacevole a lungo, distinguendosi così dagli altri piatti per la più alta qualità sul mercato ed il copripiletta è dello stesso colore e materiale del piatto.

Questi piatti mantengono a lungo una temperatura ottimale, in quanto sono calde al tatto e garantiscono un incredibile comfort di utilizzo del bagno; inoltre il Mineral Composite non favorisce lo sviluppo di batteri e non assorbe acqua né sostanze chimiche, garantendo qualità e facile conservazione della sua superficie per molto tempo.

**EN** Platform shower trays surfaces are made with a Mineral Composite, polymerized, mixed homogeneously with particles of pigment and quartz; the outer surface is protected by a coating based on nanotechnology and this allows the product to remain pleasant long, distinguishing itself from the other shower trays for the highest quality on the market and the drain cover is the same color and material as the plate.

These shower trays retain long an optimal temperature as are hot to the touch and provide incredible comfort in the bathroom; also the Mineral Composite is not conducive to the development of bacteria and does not absorb water nor chemicals, guaranteeing quality and easy storage of its surface for a long time.

**ES** Las superficies de los platos de ducha de Platform están hechas de un compuesto mineral, una resina polimerizada, mezclada homogéneamente con partículas de pigmento y cuarzo; La superficie externa está protegida por un recubrimiento basado en nanotecnología, que permite que el producto permanezca agradable durante mucho tiempo, distinguiéndose así de otros platos por la calidad más alta del mercado y la cubierta de drenaje es del mismo color y material que la placa. Estos platos mantienen una temperatura óptima durante mucho tiempo, ya que son cálidos al tacto y garantizan una increíble comodidad de uso del baño; Además, el compuesto mineral no favorece el desarrollo de bacterias y no absorbe agua o productos químicos, lo que garantiza la calidad y la fácil conservación de su superficie durante mucho tiempo.



**PT** As superfícies das placas de plataforma são feitas de um composto mineral, uma resina polimerizada, homogeneamente misturada com partículas de pigmento e quartzo; a superfície externa é protegida por um revestimento à base de nanotecnologia e isso permite que o produto permaneça macio e agradável por um longo tempo, distinguindo-se de outros pratos para a mais alta qualidade do mercado e a tampa de drenagem é da mesma cor e material que a placa.

Estes pratos mantêm uma temperatura ótima durante muito tempo, pois são quentes ao toque e garantem um incrível conforto de utilização da casa de banho; Além disso, o Compósito Mineral não favorece o desenvolvimento de bactérias e não absorve água ou produtos químicos, garantindo a qualidade e a fácil conservação de sua superfície por um longo tempo.

**FR** Les surfaces des receveurs Platform sont réalisées avec le Mineral Composite, une résine polymérisée mélangée de façon homogène avec particules de pigment et de quartz. La surface extérieure est protégée par un revêtement à base de nanotechnologies qui permet au produit de rester longtemps agréable, se distinguant ainsi des autres receveurs pour sa plus haute qualité sur le marché et le cache de la bonde de la même couleur, ainsi que des matériaux utilisés pour la fabrication du receveur. Ces receveurs maintiennent prolongée une température optimale, ils restent à température mitigée au touché et assurent un extraordinaire confort d'utilisation dans la salle de bain. De plus, le Mineral Composite empêche le développement des bactéries et n'absorbe pas l'eau et les éventuels agents chimiques, tout en assurant une qualité et un état conforme de sa surface pendant longtemps.

**DE** Diesen Duschtassen sind aus einem mineralischen Verbundstoff "Mineral Composite" hergestellt, ein Polymer-Harz, gemischte Pigmente und Quarzpartikel. Ihre äußere Oberfläche wird durch eine Beschichtung auf Basis der Nanotechnologie geschützt, wodurch das Produkt für lange Zeit angenehm bleibt. Auf diese Weise, unterscheiden sie sich von anderen am Markt erhältlichen Duschtassen auf höchstem Qualitätslevel. Die Ablaufabdeckung ist aus dem gleichen Material und Farbton gefertigt. Diese Duschtassen halten lange Zeit eine optimale Temperatur, für einen unglaublichen Nutzungskomfort des Bades. Mineral Composite ist hygienisch und ist gegen Wasser und chemischen Substanzen und Bakterien abweisend, um die Qualität der Oberfläche für eine lange Zeit zu gewährleisten.









**IT** Resistente agli urti  
**EN** Resistant to shocks  
**ES** Resistente a los golpes

**PT** Resistente a choques  
**FR** Résistant aux chocs  
**DE** Stoßfest



**IT** Resistente agli sbalzi termici  
**EN** Resistant to thermal changes  
**ES** Resistente a los cambios térmicos

**PT** Resistente a alterações térmicas  
**FR** Résistant aux variations thermiques  
**DE** Temperaturwechselbeständig



**IT** Resistente ai raggi UV  
**EN** Resistant to UV rays  
**ES** Resistente a los rayos UV

**PT** Resistente aos raios UV  
**FR** Résistant aux rayons UV  
**DE** UV beständig



**IT** Antiscivolo  
**EN** Non-slip  
**ES** Antideslizante

**PT** Antiderrapante  
**FR** Antidérapant  
**DE** Rutschhemmend



**IT** Resistente alle macchie  
**EN** Resistant to stains  
**ES** Resistente a las manchas

**PT** Resistente a manchas  
**FR** Résistant aux tâches  
**DE** Schmutzabweisend



**IT** Antibatterico  
**EN** Antibacterial  
**ES** Antibacteriano

**PT** Antibacteriano  
**FR** Antibactérien  
**DE** Antibakteriell





**IT** I piatti doccia Platform hanno un'unica finitura, con una superficie opaca con texture stone.

**EN** The Platform shower trays have a single finish, with a matt surface with stone texture.

**ES** Platos de ducha de Platform tienen un acabado único, con una superficie mate con textura de piedra.

**PT** As bases de duche Platform têm um acabamento único, com uma superfície mate com textura de pedra.

**FR** Les receveurs Platform ont une finition unique, avec une surface opaque avec texture stone.

**DE** Die Duschtassen Platform haben eine einzige Ausführung, mit matten Oberfläche und texture-stone Effekt.

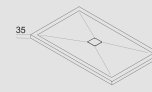

70x90	80x100	90x90
70x100	80x120	90x120
70x120	80x140	

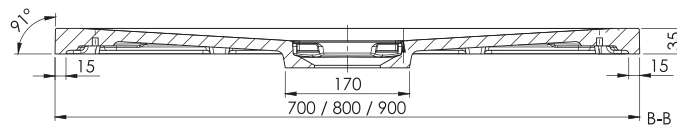
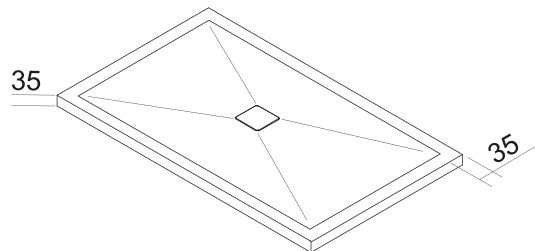

# DETAIL

**IT** Le esigenze di design nei bagni moderni sono elevatissime. I piatti doccia devono essere a filo pavimento, facili da installare e versatili per essere integrati nelle stanze da bagno. A tal fine Megius ha sviluppato i piatti Detail, capaci di soddisfare qualsiasi esigenza.

I piatti Detail sono realizzati con un Mineral Composite, una resina polimerizzata, miscelata omogeneamente con particelle di pigmento e di quarzo; per questa tipologia di piatti il copripiletta si distingue dagli altri per la sua particolare forma rettangolare.

**EN** The needs of design in the modern bathrooms are very high. Shower trays must be flush with the floor, easy to install and versatile to be integrated in the bathrooms. To this end Megius developed shower trays Detail, able to satisfy all requirements.

The shower trays are made using a Mineral Composite Detail polymerized, mixed homogeneously with particles of pigment and quartz; for this type of shower tray the drain cover differs from the others thanks to its particular rectangular shape.

**ES** The needs of design in the modern bathrooms are very high. Shower trays must be flush with the floor, easy to install and versatile to be integrated in the bathrooms. To this end Megius developed dishes Detail, able to satisfy all requirements.

The shower trays are made using a Mineral Composite Detail polymerized, mixed homogeneously with particles of pigment and quartz; for this type of shower tray the drain cover differs from the others thanks to its particular rectangular shape.



**PT** As necessidades de design em banheiros modernos são muito altas. As bandejas de duche devem estar niveladas com o chão, fáceis de instalar e versáteis para serem integradas nas casas de banho. Para este fim, a Megius desenvolveu as placas Detail, capazes de satisfazer qualquer necessidade. As placas de detalhe são feitas com um composto mineral, uma resina polimerizada, homogeneamente misturada com partículas de pigmento e quartzo; para este tipo de pratos, o dreno de tampa destaca-se dos outros pela sua forma retangular particular.

**FR** Les exigences de design des salles de bains modernes sont très élevées. Les receveurs doivent être souvent installés ras le sol, faciles à installer et polyvalentes pour s'intégrer dans les salles de bains. Dans ce but, Megius a élaboré les receveurs Detail, pour répondre à toutes les exigences. Les receveurs Detail sont réalisés avec le Mineral Composite, une résine polymérisée mélangée d'une manière homogène avec particules de pigment et de quartz; pour cette catégorie de receveurs le couvercle de la bonde se distingue des autres grâce à sa forme rectangulaire.

**DE** Die Anforderungen an Design in modernen Badezimmern sind sehr hoch. Die Duschtassen müssen bodeneben, einfach zu installieren und vielseitig und im Badezimmer perfekt integrierbar sein. Zu diesem Zweck hat Megius die Detail Duschtassen entwickelt; die jeder Anfrage entsprechen. Die Detail Duschtassen sind aus einem mineralischen Verbundstoff hergestellt, ein Polymer-Harz, gemischte Pigmente und Quarzpartikeln. Bei dieser Art der Duschtassen unterscheidet sich das rechteckige Design der Ablaufabdeckung von den anderen Duschtassen.

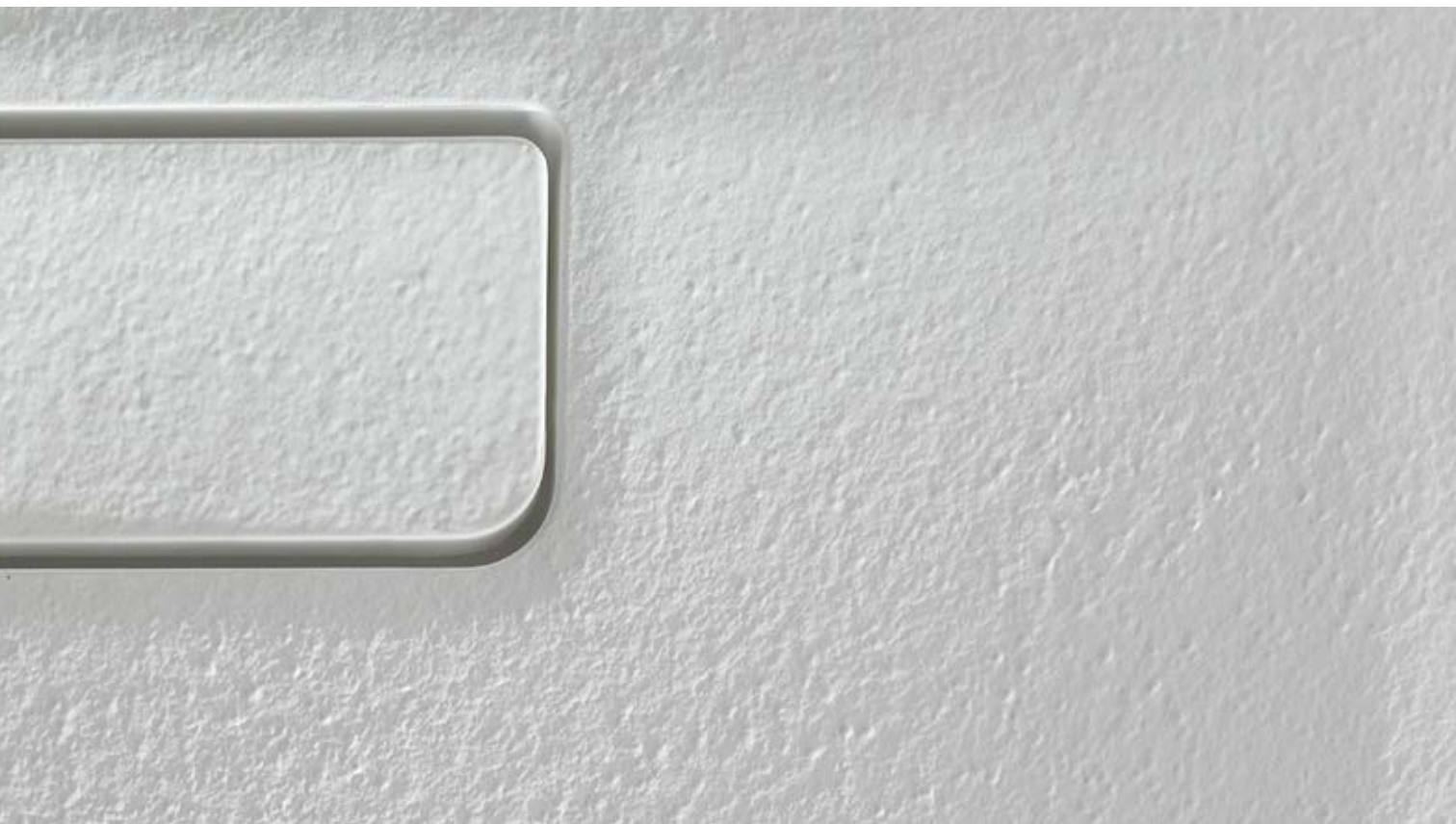





**IT** Resistente agli urti  
**EN** Resistant to shocks  
**ES** Resistente a los golpes

**PT** Resistente a choques  
**FR** Résistant aux chocs  
**DE** Stoßfest



**IT** Resistente agli sbalzi termici  
**EN** Resistant to thermal changes  
**ES** Resistente a los cambios térmicos

**PT** Resistente a alterações térmicas  
**FR** Résistant aux variations thermiques  
**DE** Temperaturwechselbeständig



**IT** Resistente ai raggi UV  
**EN** Resistant to UV rays  
**ES** Resistente a los rayos UV

**PT** Resistente aos raios UV  
**FR** Résistant aux rayons UV  
**DE** UV beständig



**IT** Antiscivolo  
**EN** Non-slip  
**ES** Antideslizante

**PT** Antiderrapante  
**FR** Antidérapant  
**DE** Rutschhemmend



**IT** Resistente alle macchie  
**EN** Resistant to stains  
**ES** Resistente a las manchas

**PT** Resistente a manchas  
**FR** Résistant aux tâches  
**DE** Schmutzabweisend



**IT** Antibatterico  
**EN** Antibacterial  
**ES** Antibacteriano

**PT** Antibacteriano  
**FR** Antibactérien  
**DE** Antibakteriell

**IT** Il piatto Detail essendo composto da una miscela di minerali e resine, si può trovare nelle seguenti colorazioni: Pietra Milk, Pietra Sand, Pietra Fog, Pietra Night Star.

**EN** The Detail shower trays being composed of a mixture of minerals and resins, it can be found in the following colours: Pietra Milk, Pietra Sand, Pietra Fog, Milk, Pietra Night Star.

**ES** Los platos de ducha Detail, compuesta de una mezcla de minerales y resinas, se puede encontrar en los siguientes colores: Pietra Milk, Pietra Sand, Pietra Fog, Pietra Night Star.

**PT** A placa Detail é composta por uma mistura de minerais e resinas, podendo ser encontrada nas seguintes cores: Pedra do Leite, Pedra da Areia, Nevoeiro de Pedra, Estrela da Noite de Pedra.

**FR** Réalisé par un mélange des minéraux et résines, le receveur Detail est réalisable dans les colorations suivantes: Pietra Milk, Pietra Sand, Pietra Fog, Pietra Night Star.

**DE** Da die Duschtasse Detail aus eine Mischung von Mineralien und Harze hergestellt sind, können wir sie in die folgenden Farben herstellen: Pietra Milk, Pietra Sand, Pietra Fog, Pietra Night Star.

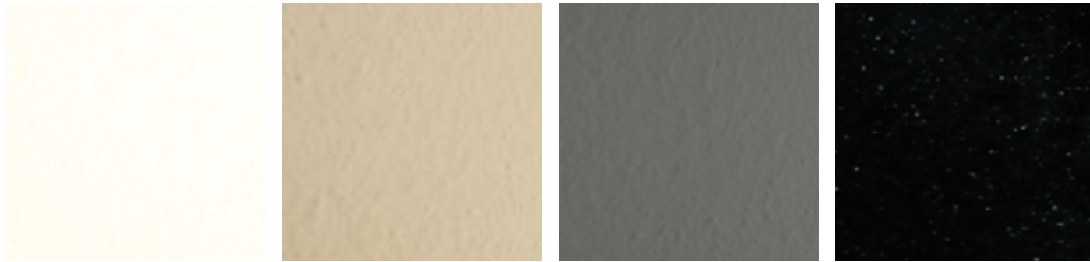

Pietra Milk - **1**

Pietra Sand - **2**

Pietra Fog - **3**

Pietra Night Star - **4**

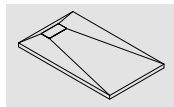

80x80
90x70
90x90
100x70
100x80
120x70
120x80
140x80
160x80

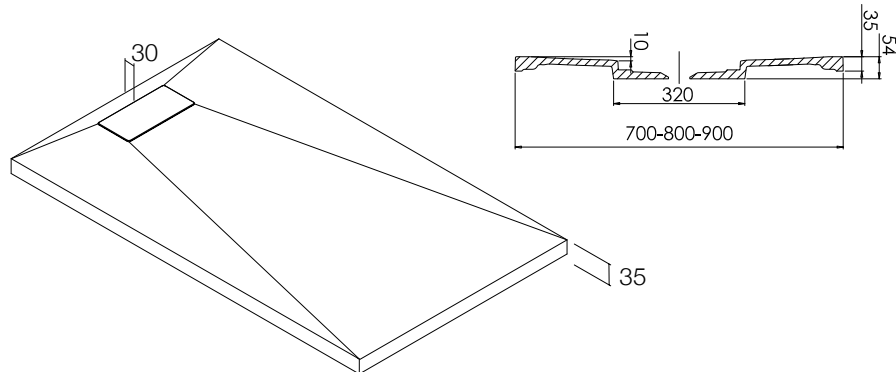



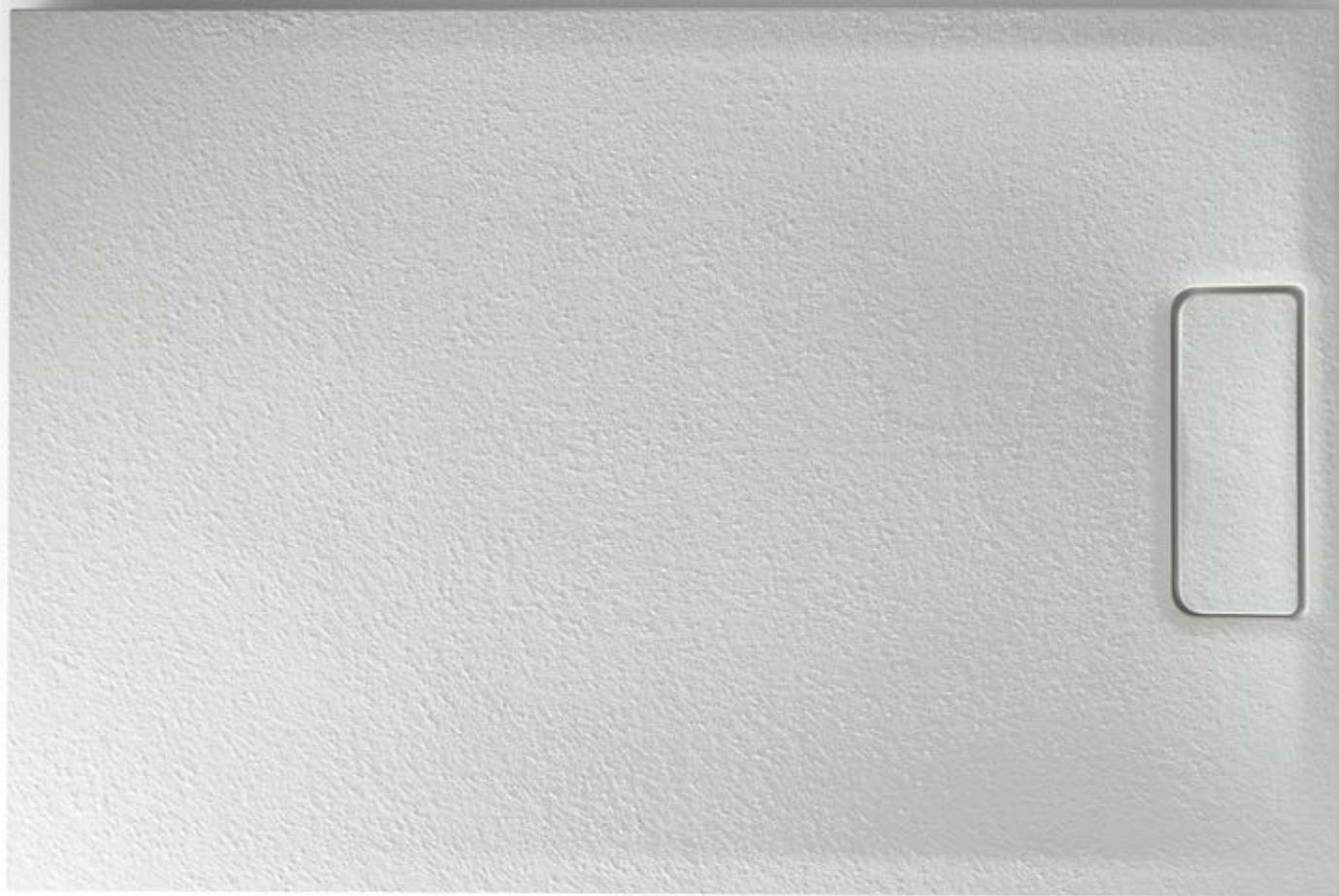





# CORIAN®

**IT** I piatti doccia Corian®, sono adatti se siete alla ricerca di un materiale elegante, di forme fluide e setose.

Materiale solido non poroso e omogeneo, è composto per 1/3 da resina acrilica (PMMA) e per 2/3 di minerali naturali. Il componente principale è triidrato di alluminio (ATH) derivato dalla bauxite.

Riparabile, solido, traslucido, lavorabile come il legno, igienico, atossico, ecologico.

**EN** Corian® shower trays are suitable if you are looking for an elegant, flowing shapes and silky material.

Designed with non-porous, homogeneous solid material, is made for 1/3 by acrylic resin (PMMA) and for 2/3 of natural minerals. The major component is aluminium trihydrate (ATH) derived from Bauxite. Repairable, solid, translucent, workable as wood, hygienic, non-toxic, ecological.

**ES** Los platos de ducha de Corian® son adecuados si buscas un material elegante, con formas fluidas y sedosas. Diseñado con un material sólido no poroso y homogéneo, está compuesto de 1/3 de resina acrílica (PMMA) y 2/3 de minerales naturales. El componente principal es trihidrato de aluminio (ATH) derivado de la Bauxite. Reparable, sólido, translúcido, manejable como la madera, higiénico, no tóxico, ecológico.



**PT** Bandejas de chuveiro Corian® são adequadas se você estiver procurando por um material elegante, com formas fluidas e sedosas. Projetado com um material sólido não poroso e homogêneo, é composto de 1/3 de resina acrílica (PMMA) e 2/3 de minerais naturais. O principal componente é o tri-hidrato de alumínio (ATH) derivado da bruxite. Reportável, sólido, translúcido, trabalhável como madeira, higiênico, não tóxico, ecológico.

**FR** Si vous recherchez un matériau élégant, avec formes fluides et soigneux, les receveurs Corian® seront sans aucun doute les plus appropriés.

Réalisé par un matériau solide, pas poreux et homogène; ils se composent pour 1/3 de résine acrylique (PMMA), et pour 2/3 de minéraux naturels.

L'élément principal est le trihydrate d'aluminium (ATH), dérivé de la bauxite.

**DE** Korian-Duschen eignen sich, wenn Sie auf der Suche nach einer eleganten, fließenden Form und seidigem Material sind. Die aus festem, homogenem Feststoff entwickelte Duschtasse besteht zu 1/3 aus Acrylharz (PMMA) und zu 2/3 aus natürlichen Mineralien. Der Hauptbestandteil ist Aluminiumtrihydrat (ATH), das aus Bauxit gewonnen wird. Die Eigenschaften sind: Reparabel, fest, lichtdurchlässig, bearbeitbar wie Holz, hygienisch, ungiftig und ökologisch.





**IT** Resistente agli urti  
**EN** Resistant to shocks  
**ES** Resistente a los golpes

**PT** Resistente a choques  
**FR** Résistant aux chocs  
**DE** Stoßfest



**IT** Resistente agli sbalzi termici  
**EN** Resistant to thermal changes  
**ES** Resistente a los cambios térmicos

**PT** Resistente a alterações térmicas  
**FR** Résistant aux variations thermiques  
**DE** Temperaturwechselbeständig



**IT** Resistente ai raggi UV  
**EN** Resistant to UV rays  
**ES** Resistente a los rayos UV

**PT** Resistente aos raios UV  
**FR** Résistant aux rayons UV  
**DE** UV beständig



**IT** Antiscivolo  
**EN** Non-slip  
**ES** Antideslizante

**PT** Antiderrapante  
**FR** Antidérapant  
**DE** Rutschhemmend



**IT** Resistente alle macchie  
**EN** Resistant to stains  
**ES** Resistente a las manchas

**PT** Resistente a manchas  
**FR** Résistant aux tâches  
**DE** Schmutzabweisend



**IT** Antibatterico  
**EN** Antibacterial  
**ES** Antibacteriano

**PT** Antibacteriano  
**FR** Antibactérien  
**DE** Antibakteriell

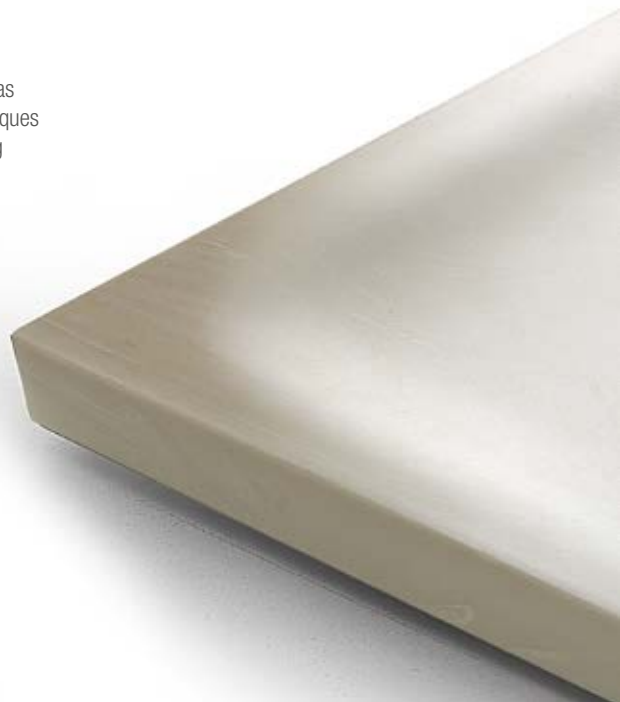



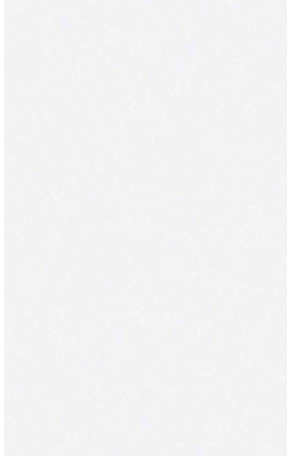

Corian® Glacier White - I



Corian® Nimbus Prima - N



Corian® Raffia - R



Corian® Neutral Concrete - U

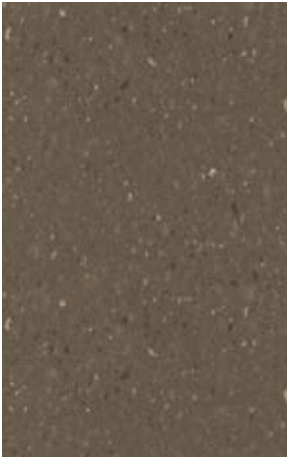

Corian® Sienna Brown - B



Corian® Carbon Concrete - K



Corian® Mineral - M



Corian® Cosmo Prima - P





**IT** Doiserie è il nuovo sistema di arredamento per la doccia Megius che si compone di pannelli e piatti doccia coordinati in Corian®. Cambiano così le prospettive: il progetto doccia si plasma come un'opera a tuttotondo.

**EN** Doiserie is the new furniture system for Megius shower area which consists of shower panels and trays made of Corian®. In this way perspectives change: the shower project takes shape as a work in the round.

**ES** Doiserie es el nuevo sistema de decoración por la ducha Megius que se compone de paneles y platos de ducha coordinada en compuestos Corian®. Cambian así las perspectivas: el proyecto ducha se plasma como una obra.

**PT** Doiserie é o novo sistema de mobílias para o chuveiro Megius que consiste em painéis e bases de duche coordenadas em compósitos Corian®. Eles mudam assim as perspectivas: o projeto do chuveiro tem a forma de um obra de arte.

**FR** Doiserie est le nouveau système de meubles pour le zone de douche Megius qui se compose de panneaux de douche et des plateaux en Corian®. De cette façon, les perspectives changent: le projet d'eau prend forme comme une œuvre dans la ronde.

**DE** Doiserie ist das neue Möbelsystem für Megius Duschbereich, die Platten und Schalen mit Dusche von Corian®. Auf diese Weise Perspektiven ändern: die Dusche Projekt nimmt Gestalt an als ein Werk in der Runde.





**IT** Sono disponibili diverse colorazioni che vanno dal classico Glacier White al Nimbus Prima, al Raffia, al Neutral Concrete, al Sienna Brown, al Mineral, al Carbon Concrete al Cosmo Prima per un ottimale abbinamento con gli altri elementi inseriti nel bagno. Le superfici in Corian® sono igieniche. Essendo un materiale non poroso, muffe e batteri non possono proliferare sulla sua superficie.

**EN** Are available different colours ranging from classical Glacier White at Nimbus Prima, Raffia, at Neutral Concrete, the Sienna Brown, the Mineral, the Carbon Concrete to the Cosmos Prima for optimum combined with other elements included in the bathroom. Corian® surfaces they are hygienic. Being a non-porous material, mould and bacteria cannot spread in the seams or below the surface.

**ES** Están disponibles en diferentes colores, desde el clásico Glacier White hasta el Nimbus Prima, el Raffia, el Neutral Concrete, el Sienna Brown, el Mineral, el Carbon Concrete hasta el Cosmo Prima para una combinación óptima con los otros elementos insertados en el baño. Las superficies de Corian® son higiénicas. Al ser un material no poroso, el moho y las bacterias no pueden propagarse a las articulaciones o debajo de la superficie.

**PT** Acabamento único, mas cores diferentes estão disponíveis desde o clássico Glacier White até o Nimbus Prima, o Raffia, o Neutral Concrete, o Sienna Brown, o Mineral, o Carbon Concrete ao Cosmo Prima para uma ótima combinação com os outros elementos inseridos no banheiro. As superfícies de Corian® são higiênicas. Sendo um material não poroso, o mofo e as bactérias não podem se espalhar nas juntas ou sob a superfície.

**FR** Il sont disponibles diverses teintes qui varient du classique Glacier White, au Nimbus Prima, au Raffia, au Neutral Concrete, au Sienna Brown, au Mineral et au Carbon Concrete Cosmo Prima, ceci dans le but d'offrir une coordination optimale avec les autres éléments de la salle de bain. Les surfaces en Corian® sont hygiéniques, car réalisées avec un matériau pas poreux, les moisissures et les bactéries ne peuvent pas se propager dans les joints ou sous la surface.

**DE** Da sie aus einem festen Material sind, können sich Schimmels und Bakterien nicht verbreiten. Die Oberfläche aus Korian sind hygenisch. Corian® Duschtassen gibt es verschiedene verfügbaren Farben. Die Farben sind: klassisches Glacier White, Nimbus Prima, Raffia, Neutral Concrete, Sienna Brown, Mineral, Carbon Concrete, Cosmo Prima, für eine optimale Kombination mit den anderen Elementen des Badezimmers.

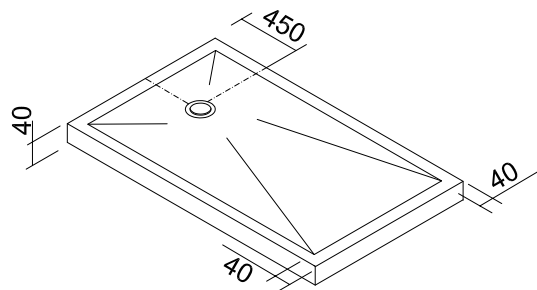

# POLICORE

**IT** I piatti doccia Policore si presentano con un design minimale ma ricercato: si tratta di un piatto composito stratificato, le cui finiture superficiali possono variare ed essere in bianco opaco e in tante colorazioni diverse.

**EN** Policore shower trays have a minimal but sophisticated design: it is a stratified composite shower tray, whose surface finishes may vary and be composed in Matt white and in many different colors.

**ES** Los platos de ducha Policore tienen un diseño minimalista pero sofisticado: es un plato de ducha de material compuesto estratificado, cuyos acabados superficiales pueden variar y ser en blanco opaco y en muchas coloraciones diferentes.



**PT** As bases de duche Policore têm um design minimalista mas sofisticado: é um painel compósito laminado, cujos acabamentos de superfície podem variar e ser compostos por materiais diferentes, como acabamento de metacrilato branco.

**FR** Les receveurs Policore se présentent avec un design minimaliste mais d'effet : il s'agit d'un receveur réalisé en composite, ses finitions superficielles peuvent varier et être composée par différent matériaux; comme par exemple la finition blanche et autres différentes couleurs.

**DE** Die Duschtassen Policore zeigen sich mit einem minimalistischen und elegantem Design. Es handelt sich dabei um eine laminierte Verbundplatte, deren Oberfläche variieren kann. Dies sind beispielweise Oberflächen wie Acryl mit weißen Finish, und mit anderen verchiedenen farben.





**IT** Resistente agli urti  
**EN** Resistant to shocks  
**ES** Resistente a los golpes

**PT** Resistente a choques  
**FR** Résistant aux chocs  
**DE** Stoßfest



**IT** Resistente agli sbalzi termici  
**EN** Resistant to thermal changes  
**ES** Resistente a los cambios térmicos

**PT** Resistente a alterações térmicas  
**FR** Résistant aux variations thermiques  
**DE** Temperaturwechselbeständig



**IT** Resistente ai raggi UV  
**EN** Resistant to UV rays  
**ES** Resistente a los rayos UV

**PT** Resistente aos raios UV  
**FR** Résistant aux rayons UV  
**DE** UV beständig



**IT** Antiscivolo  
**EN** Non-slip  
**ES** Antideslizante

**PT** Antiderrapante  
**FR** Antidérapant  
**DE** Rutschhemmend



**IT** Resistente alle macchie  
**EN** Resistant to stains  
**ES** Resistente a las manchas

**PT** Resistente a manchas  
**FR** Résistant aux tâches  
**DE** Schmutzabweisend



**IT** Antibatterico  
**EN** Antibacterial  
**ES** Antibacteriano

**PT** Antibacteriano  
**FR** Antibactérien  
**DE** Antibakteriell









**IT** Per i piatti Policore sono disponibili diverse colorazioni che vanno dal Policore Ice al Policore Primavera Climb, al Policore Sahara, al Policore Mud, al Policore Etna, al Policore Industrial Grey, al Policore Grey Jeans, Policore Nero al Policore Nero Climb per un ottimale abbinamento con gli altri elementi inseriti nel bagno.

**EN** Policore shower trays are available in different colours ranging from Policore Ice to Policore Primavera Climb, Policore Sahara, Policore Mud, Policore Etna, Policore Industrial Gray, Policore Gray Jeans, Policore Nero to Policore Nero Climb for an optimal combination with the other elements inserted in the bathroom.

**ES** Los platos Policore están disponibles en diferentes colores, desde Policore Ice a Policore Primavera Climb, a Policore Sahara, a Policore Mud, a Policore Etna, a Policore Industrial Grey, a Policore Grey Jeans, Policore Nero a Policore Nero para una combinación óptima con los otros elementos insertados en el baño.

**PT** Pratos Policore estão disponíveis em diferentes cores, desde Policore Ice até Policore Spring Climb, Policore Sahara, Lama Policore, Policore Etna, Policore Cinza Industrial, Policore Grey Jeans, Policore Black a Policore Black Climb, para uma combinação ideal com os outros elementos inseridos no banheiro.

**FR** Pour les receveurs Policore existent diverses teintes qui varient du Policore Ice au Policore Primavera Climb, au Policore Sahara, au Policore Mud, au Policore Etna, au Policore Industrial Grey, au Policore Grey Jeans, au Policore, pour terminer par le Policore Noir Climb, pour une coordination optimale avec les autres éléments de la saille de bain.

**DE** Policore Duschtassen gibt es in verschiedenen Farben: Policore Ice, Policore Primavera Climb, Policore Sahara, Policore Mud, Policore Etna, Policore Industrial Grey, Policore Grey Jeans, Policore Schwarz und Policore Schwarz Climb, für eine optimale Kombination mit den anderen Elementen im Badezimmer.

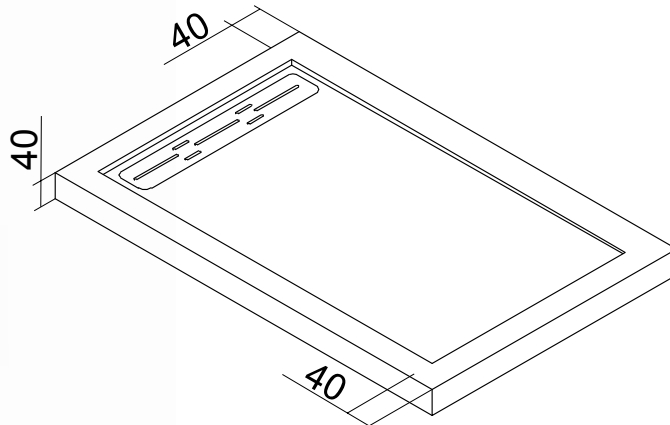

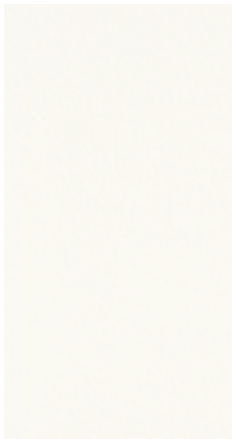

Polycore Ice - **I**

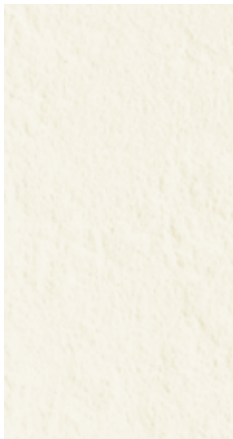

Polycore Bianco Primavera Climb  
- **C**

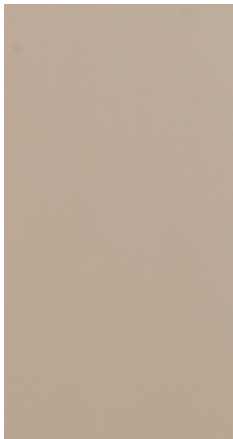

Polycore Sahara - **Y**



Polycore Mud - **F**



Polycore Etna - **K**



Polycore industrial Grey - **Z**



Polycore Grey Jeans - **J**

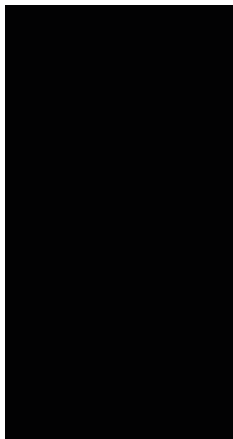

Polycore Nero - **O**



Polycore Nero Climb - **U**



**IT** Doiserie è il nuovo sistema di arredamento per la doccia Megius che si compone di pannelli e piatti doccia coordinati in pannelli compositi Policore. Cambiano così le prospettive: il progetto doccia si plasma come un'opera a tuttotondo.

**EN** Doiserie is the new furniture system for Megius shower area which consists of shower panels and trays made of Policore composite panels. In this way perspectives change: the shower project takes shape as a work in the round.

**ES** Doiserie es el nuevo sistema de decoración por la ducha Megius que se compone de paneles y platos de ducha coordinada en compuestos Policore. Cambian así las perspectivas: el proyecto ducha se plasma como una obra.

**PT** Doiserie é o novo sistema de móveis para o chuveiro Megius que consiste em painéis e bases de duche coordenadas em compósitos Policore. Eles mudam assim as perspectivas: o projeto do chuveiro tem a forma de um obra de arte.

**FR** Doiserie est le nouveau système de meubles pour le zone de douche Megius qui se compose de panneaux de douche et des plateaux en panneaux composites ou Polycore. De cette façon, les perspectives changent: le projet d'eau prend forme comme une œuvre dans la ronde.

**DE** Doiserie ist das neue Möbelsystem für Megius Duschbereich, die Platten und Schalen mit Dusche von Polycore Verbundplatten hergestellt besteht. Auf diese Weise Perspektiven ändern: die Dusche Projekt nimmt Gestalt an als ein Werk in der Runde.



# KRILUX

**IT** Con l'evolversi delle tecnologie i composti come l'acrilico hanno iniziato ad affermarsi, andando a competere con la ceramica.

I piatti in Acrilico Krilux sono caratterizzati da una superficie liscia, donando una sensazione piacevole al contatto e una buona presa con la pelle, evitando lo spiacevole effetto "planing" causa di possibili cadute.

L'alta resistenza a piccoli urti e graffi, la leggerezza, lo spessore ridotto e l'adattabilità ad ogni tipo di forma, tra cui quadrato, rettangolare e stonato, sono i punti di forza del Piatto Krilux, facendo mantenere un aspetto "come nuovo" molto più a lungo, dato che l'acrilico è un materiale difficile da sporcare.

**EN** With the evolution of technology acrylic compounds have begun to assert itself, going to compete with ceramics. Krilux acrylic shower trays feature a smooth surface, giving a pleasant feeling to the touch and a good grip with skin, avoiding the unpleasant effect "planing" due to fall.

High resistance to small bumps and scratches, light weight, reduced thickness and adaptability to all types of forms, including square, rectangular and rounded, are the strengths of the pot Krilux, by maintaining a "like new" appearance much longer, since acrylic is a difficult material to soil.

**ES** A medida que las tecnologías evolucionan, los compuestos como el acrílico han comenzado a establecerse, compitiendo con la cerámica. Platos de ducha en acrílico Krilux se caracterizan por una superficie lisa, que proporciona una sensación agradable al tacto y un buen agarre con la piel, evitando el desagradable efecto "alisador" debido a posibles caídas. La alta resistencia a los pequeños golpes y rasguños, la ligereza, el grosor reducido y la adaptabilidad a cualquier tipo de forma, incluso cuadradas, rectangulares y redondeadas, son las fortalezas de la placa Krilux, manteniendo un aspecto "como nuevo". Mucho más tiempo, ya que el acrílico es un material difícil de manchar.



**PT** À medida que as tecnologias evoluem, compostos como o acrílico começam a se estabelecer competindo com a cerâmica. As placas Acrílicas Krilux caracterizam-se por uma superfície lisa, proporcionando uma sensação agradável ao toque e uma boa aderência com a pele, evitando o desagradável efeito “aplainar” devido a possíveis quedas. A alta resistência a pequenas saliências e arranhões, leveza, espessura reduzida e adaptabilidade a qualquer tipo de formato, incluindo quadrado, retangular e arredondado, são os pontos fortes da placa Krilux, mantendo um visual “tão bom quanto novo”. Muito mais tempo, uma vez que o acrílico é um material difícil para o solo.

**FR** Avec l'évolution des technologies offertes à l'industrie, des nouveaux composites tels que l'acrylique ont commencés à s'implanter, faisant parfois concurrence aux céramiques. Les receveurs en acrylique Krilux se caractérisent par une surface lisse, donnant une sensation agréable au touché et une bonne adhérence sur la peau, évitant ainsi "l'effet planant", raison d'éventuelles tombées. La résistance élevée aux petites bosses et aux égratignures, la légèreté, la réduction d'épaisseur et l'adaptabilité à tout type de forme, y-compris celle carrée, rectangulaire et arrondie, sont les points forts du receveur Krilux, gardant un aspect "comme neuf" beaucoup plus longtemps, étant donné que l'acrylique est un matériau difficile à abîmer.

**DE** Mit der Entwicklung der Technologie der Acrylverarbeitung bei Duschwannen wurde der klassischen Keramik ein großer Konkurrent gegenübergestellt, der sich in einigen Bereichen behaupten konnte. Krilux Acrylplatten zeichnen sich durch eine glatte Oberfläche aus, die ein angenehmes Gefühl für die Berührung vereinen mit einem guten Halt und ausgezeichneter Rutschhemmung. Hohe Beständigkeit gegen kleine Beulen und Kratzer, geringes Gewicht, reduzierte Höhe und die einfache Anpassungsfähigkeit an alle Arten von Formen, einschließlich quadratische, rechteckige oder abgerundete Formen, sind die Stärken der Dusche Krilux, die auch ihr neuwertiges Aussehen bei entsprechender Pflege viel länger beibehält, da Acryl besonders im Bodenbereich ein empfindliches Material ist.

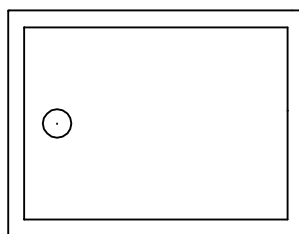

H. 4 cm

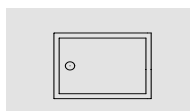

- 900 x 720 mm
- 1.000 x 700 mm
- 1.000 x 800 mm
- 1.200 x 800 mm
- 1.200 x 700 mm
- 1.400 x 700 mm
- 1.400 x 800 mm
- 1.600 x 800 mm
- 1.700 x 700 mm

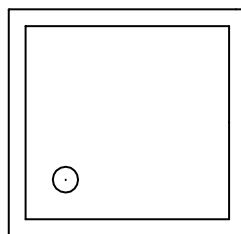

H. 4 cm

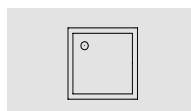

- 800 x 800 mm
- 900 x 900 mm

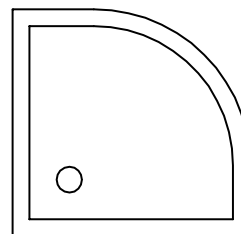

H. 4 / 5 cm

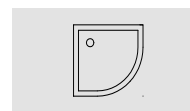

- 800 x 800 mm
- 900 x 900 mm

# ATOLLO

**IT** Le pedane Atollo sono realizzate in legno multistrato marino, di spessore 30 mm, dotate di particolari tappi di gomma antisdrucchiolo e trattate con impregnante antimuffa.

Il design semplice, la praticità e le diverse tipologie di forma quadrata, rettangolare o stondata, distinguono il prodotto.

**EN** The wooden platform Atollo are made of marine plywood, 30 mm thick, with special non-slip rubber caps and treat with anti-mold impregnant. Simple design, functionality and the different type of square, rectangular or round shape, distinguish the product.

**ES** Tablas de ducha Atollo están hechos de madera contrachapada marina, de 30 mm de grosor, equipados con tapones de goma antideslizantes especiales y de rótula con impregnación contra moldes. El diseño simple, la practicidad y los diferentes tipos de forma cuadrada, rectangular o redondeada distinguen el producto.

**PT** As sapatilhas Atollo são feitas de contraplacado marítimo de 30 mm de espessura, equipadas com rolhas especiais de borracha antiderrapante e com uma impregnação antimofa.

O design simples, a praticidade e os diferentes tipos de formas quadradas, retangulares ou arredondadas distinguem o produto.

**FR** Les caillebotis Atollo sont réalisés en bois multiples marin, de 30 mm d'épaisseur, équipés de bouchons en caoutchouc antidérapant et traités avec un vernis antimycotique. Le design simple, l'aspect pratique et les différents types de formes carrées, rectangulaires ou arrondies sont un élément de distinction de ce produit.

**DE** Der Duscheinsatz Atollo besteht aus einem 30 mm starkem mehrschichtverleimten Bootsperrholz mit speziellen Antirutschkappen und einer antibakteriellen Imprägnierung. Einfaches Design, Funktionalität und die unterschiedliche Art der quadratischen, rechteckigen oder runden Form zeichnen das Produkt aus.

